

Harman Kardon HK3270 Stereo Receiver

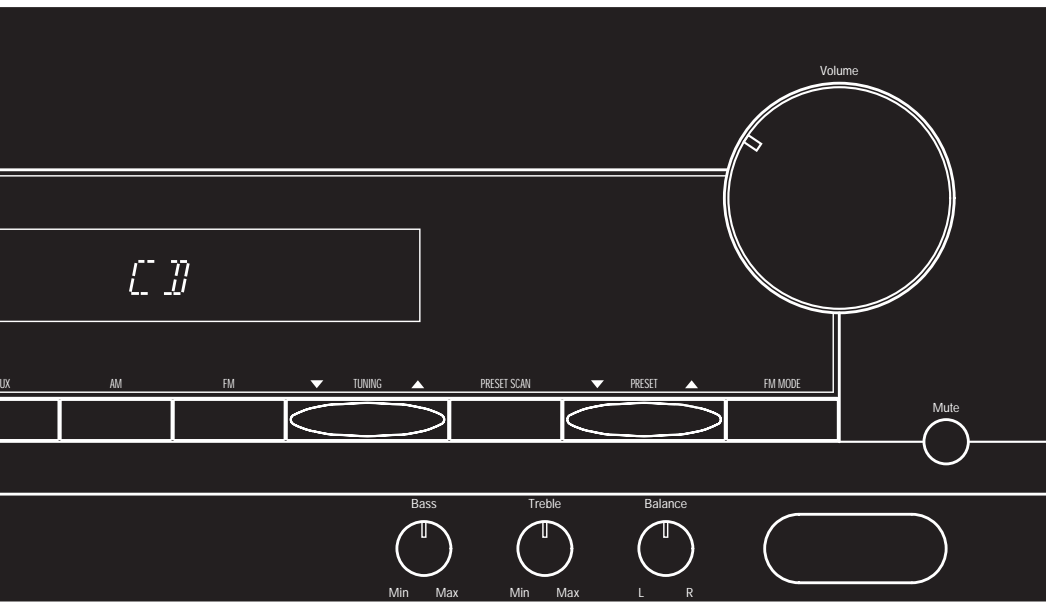

Owner's Manual

harman/kardon

Owner's Manual

HK3270 Stereo Receiver

Table of Contents

Introduction	1
Safety Information	2-3
Front Panel Controls	4-6
Rear Panel Connections	7-8
Remote Control Functions	9-10
Installation and Connections	11-13
Operation	14-18
Basic Operation	14
Source Selection	14-15
Tuner Operation	15-16
Tape Recording	16
Memory Backup	16
Processor Reset	16
Troubleshooting Guide	17
Technical Specifications	18

harman/kardon

250 Crossways Park Drive
Woodbury, NY 11797

H A Harman International Company

©1998 Harman Kardon, Incorporated

Introduction

Congratulations! With the purchase of the Harman Kardon HK3270 you are about to begin many years of listening enjoyment. The HK3270 has been custom designed to provide all the excitement and power of rock, jazz and popular music, and every nuance of classical selections.

While sophisticated systems are hard at work within the HK3270 to make all of this happen, hookup and operation are simple. Color-keyed connections and a comprehensive remote control make the HK3270 easy to use.

To obtain maximum enjoyment from your new receiver, we urge you to take a few minutes to read through this manual. This will ensure that connections to speakers, source playback units and other external devices are made properly. In addition, a few minutes spent learning the functions of the various controls will enable you to take advantage of all the power the HK3270 is able to deliver.

If you have any questions about this product, its installation or operation, please contact your dealer. They are your best local source of information.

Description and Features

The HK3270 is a full-featured Stereo receiver, with five inputs and an FM stereo/FM/AM tuner with capabilities that provide for the utmost flexibility. A high-quality phono input is available so that you may continue to enjoy your existing record collection as well as the latest CD recordings.

The HK3270's powerful amplifier uses traditional Harman Kardon High-Current Design philosophies to meet the wide dynamic range of any program selection.

Harman Kardon invented the high-fidelity receiver more than forty-five years ago. With state-of-the-art features and time-honored circuit designs, the HK3270 is one of the finest receivers ever offered by Harman Kardon.

- **Harman Kardon Designed High-Current, Ultrawide Bandwidth Amplifier**
- **Preamp and Subwoofer Outputs for Use with External Power Amplifiers**
- **Phono Input Section**
- **Tuner with Data Program Information Displays**

Safety Information

5

Important Safety Information

Verify Line Voltage Before Use

Your HK3270 has been designed for use with 120-volt AC current. Connection to a line voltage other than that for which it is intended can create a safety and fire hazard, and may damage the unit.

If you have any questions about the voltage requirements for your specific model, or about the line voltage in your area, contact your selling dealer before plugging the unit into a wall outlet.

Do Not Use Extension Cords

To avoid safety hazards, use only the power cord attached to your unit. We do not recommend that extension cords be used with this product. As with all electrical devices, do not run power cords under rugs or carpets or place heavy objects on them. Damaged power cords should be replaced immediately with cords meeting factory specifications.

Handle the AC Power Cord Gently

When disconnecting the power cord from an AC outlet, always pull the plug, never pull the cord. If you do not intend to use the unit for any considerable length of time, disconnect the plug from the AC outlet.

Do Not Open the Cabinet

There are no user-serviceable components inside this product. Opening the cabinet may present a shock hazard, and any modification to the product will void your guarantee. If water or any metal object such as a paper clip, wire or staple accidentally falls inside the unit, disconnect it from the AC power source immediately, and consult an authorized service station.

CATV or Antenna Grounding





If an outside antenna or cable system is connected to this product, be certain that it is grounded so as to provide some protection against voltage surges and static charges. Section 810 of the National Electrical Code, ANSI/NFPA No. 70-1984, provides information with respect to proper grounding of the mast and supporting structure, grounding of the lead-in wire to an antenna discharge unit, size of grounding conductors, location of antenna discharge unit, connection to grounding electrodes and requirements of the grounding electrode.

NOTE TO CATV SYSTEM INSTALLER:

This reminder is provided to call the CATV (Cable TV) system installer's attention to article 820-40 of the NEC that provides guidelines for proper grounding and, in particular, specifies that the cable ground shall be connected to the grounding system of the building, as close to the point of cable entry as possible.

Installation Location

- To assure proper operation, and to avoid the potential for safety hazards, place the unit on a firm and level surface. When placing the unit on a shelf, be certain that the shelf and any mounting hardware can support the weight of the product.
- Make certain that proper space is provided both above and below the unit for ventilation. If this product will be installed in a cabinet or other enclosed area, make certain that there is sufficient air movement within the cabinet. Under some circumstances a fan may be required.
- Do not place the unit directly on a carpeted surface.
- Avoid installation in extremely hot or cold locations, or an area that is exposed to direct sunlight or heating equipment.
- Avoid moist or humid locations.
- Do not obstruct the ventilation slots on the top of the unit, or place objects directly over them.

	CAUTION RISK OF ELECTRIC SHOCK DO NOT OPEN		
CAUTION: TO REDUCE THE RISK OF ELECTRIC SHOCK, DO NOT REMOVE COVER (OR BACK). NO USER-SERVICEABLE PARTS INSIDE. REFER SERVICING TO QUALIFIED SERVICE PERSONNEL.			
	The lightning flash with arrowhead symbol, within an equilateral triangle, is intended to alert the user to the presence of uninsulated "dangerous voltage" within the product's enclosure that may be of sufficient magnitude to constitute a risk of electric shock to persons.		The exclamation point within an equilateral triangle is intended to alert the user to the presence of important operating and maintenance (servicing) instructions in the literature accompanying the appliance.
WARNING: TO REDUCE THE RISK OF FIRE OR ELECTRIC SHOCK, DO NOT EXPOSE THIS APPLIANCE TO RAIN OR MOISTURE.			
CAUTION: TO PREVENT ELECTRIC SHOCK, MATCH WIDE BLADE OF PLUG TO WIDE SLOT, FULLY INSERT. ATTENTION: POUR EVITER LES CHOCs ELECTRIQUES, INTRODUIRE LA LAME LA PLUS LARGE DE LA FICHE DANS LA BORNE CORRESPONDANTE DE LA PRISE ET POUSSER JUSQU'AU FOND.			

Safety Information

Cleaning

When the unit gets dirty, wipe it with a clean, soft, dry cloth. If necessary, wipe it with a soft cloth dampened with mild soapy water, then a fresh cloth with clean water. Wipe dry immediately with a dry cloth. NEVER use benzene, aerosol cleaners, thinner, alcohol or any other volatile cleaning agent. Do not use abrasive cleaners, as they may damage the finish of metal parts. Avoid spraying insecticide near the unit.

Moving the Unit

Before moving the unit, be certain to disconnect any interconnection cords with other components, and make certain that you disconnect the unit from the AC outlet.

Important Information For the User

NOTE: This equipment has been tested and found to comply with the limits for a Class-B digital device, pursuant to Part 15 of the FCC Rules. The limits are designed to provide reasonable protection against harmful interference in a residential installation. This equipment generates, uses and can radiate radio-frequency energy and, if not installed and used in accordance with the instructions, may cause harmful interference to radio communication. However, there is no guarantee that harmful interference will not occur in a particular installation. If this equipment does cause harmful interference to radio or television reception, which can be determined by turning the equipment off and on, the user is encouraged to try to correct the interference by one or more of the following measures:

- Reorient or relocate the receiving antenna.
- Increase the separation between the equipment and receiver.
- Connect the equipment into an outlet on a circuit different from that to which the receiver is connected.
- Consult the dealer or an experienced radio/TV technician for help.

This device complies with Part 15 of the FCC Rules. Operation is subject to the following two conditions: (1) this device may not cause harmful interference, and (2) this device must accept interference received, including interference that may cause undesired operation.

NOTE: Changes or modifications may cause this unit to fail to comply with Part 15 of the FCC Rules and may void the user's authority to operate the equipment.

Unpacking

The carton and shipping materials used to protect your new receiver during shipment were specially designed to cushion it from shock and vibration. We suggest that you save the carton and packing materials for use in shipping if you move, or should the unit ever need repair.

To minimize the size of the carton in storage, you may wish to flatten it. This is done by carefully slitting the tape seams on the bottom and collapsing the carton down to a more two-dimensional appearance. Other cardboard inserts may be stored in the same manner. Packing materials that cannot be collapsed should be saved along with the carton in a plastic bag.

If you do not wish to save the packaging materials, please note that the carton and other sections of the shipping protection are recyclable. Please respect the environment and discard those materials at a local recycling center.

Typographic Conventions

In order to help you use this manual with the remote control, front panel controls and rear panel connections, certain conventions have been used.

Example – (bold type) indicates a specific remote control or front panel button, or rear panel connection

Example – (OCR type) indicates a message that is visible on the front panel information display

EXAMPLE – (bold type) indicates a lit indicator in the front panel information display

1 – (number in a square) indicates a specific front panel control

1 – (number in a circle) indicates a rear panel connection

A – (letter in a circle) indicates a button on the main portion of the remote control

A – (letter in a square) indicates a button under the sliding panel on the lower portion of the remote control

Front Panel Controls

7

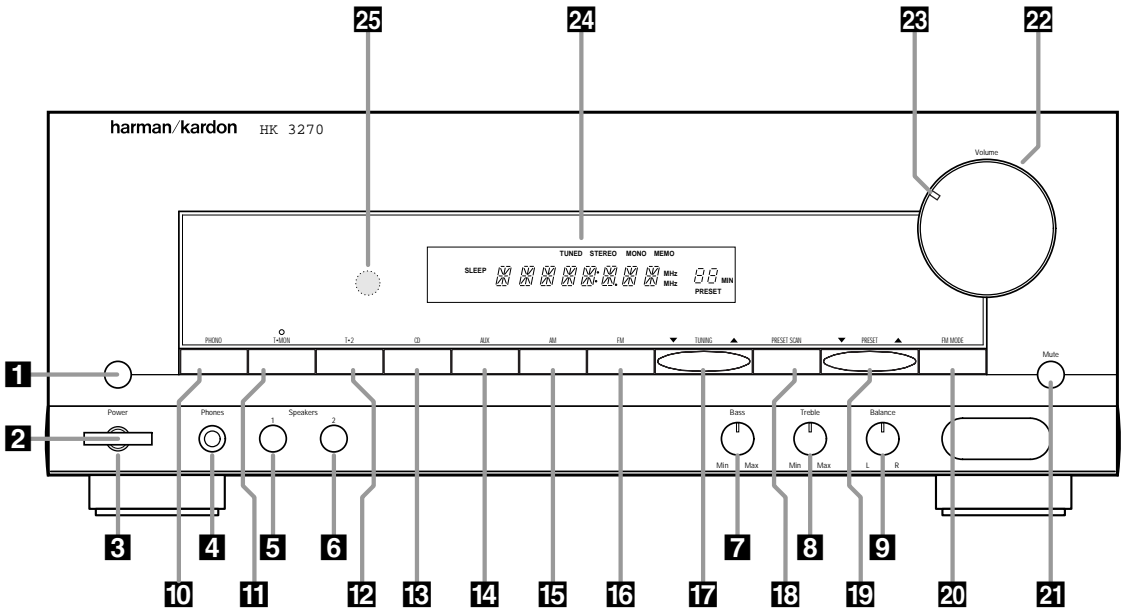

- 1** Main Power Switch
- 2** System Power Control
- 3** Power Indicator
- 4** Headphone Jack
- 5** Speaker 1 Button
- 6** Speaker 2 Button
- 7** Bass Control
- 8** Treble Control
- 9** Balance Control

- 10** Phono Button
- 11** Tape Monitor
- 12** Tape 2 Button
- 13** CD Button
- 14** Aux Button
- 15** AM Button
- 16** FM Button
- 17** Tuning Button
- 18** Preset Scan

- 19** Preset Stations Selector
- 20** FM Mode
- 21** Mute
- 22** Volume Control
- 23** Volume/Mute Indicator
- 24** Information Display
- 25** Remote Sensor Window

Front Panel Controls

8

1 Main Power Switch: Press this button to apply power to the HK3270. When the switch is pressed in the unit is placed in a Standby mode, as indicated by the amber LED **3** surrounding the **System Power Control 2**. This button MUST be pressed in to operate the unit. To turn the unit off and prevent the use of the remote control, this switch should be pressed until it pops out from the front panel so that the word "OFF" may be read at the top of the switch.

NOTE: In normal operation this switch is left in the "ON" position.

2 System Power Control: When the **Main Power Switch 1** is "ON," press this button to turn on the HK3270; press it again to turn the unit off. Note that the **Power Indicator** surrounding the switch **3** will turn green when the unit is on.

3 Power Indicator: This LED will illuminate in amber when the unit is in the Standby mode to signal that the unit is ready to be turned on. When the unit is in operation, the indicator will turn green. A red indicator means that the unit is in the Protect mode, and should be turned off and then checked for a possible speaker wire short circuit.

4 Headphone Jack: This jack may be used to listen to the HK3270's output through a pair of headphones. Be certain that the headphones have a standard 1/4" stereo phone plug.

5 Speaker 1 Button: Press this button to activate the speaker connected to the **Speaker 1** output terminals **16**.

6 Speaker 2 Button: Press this button to activate the speaker connected to the **Speaker 2** output terminals **17**.

7 Bass Control: Turn this control to modify the low-frequency output of the left/right channels by as much as ± 10 dB. Set this control to a suitable position for your taste and room acoustics.

8 Treble Control: Turn this control to modify the high-frequency output of the left/right channels by as much as ± 10 dB. Set this control to a suitable position for your taste and room acoustics.

9 Balance Control: Turn this control to change the relative volume for the front left/right channels.

10 Phono Button: Press this button to select the output of a turntable which is connected to the **Phono** inputs **6**.

11 Tape Monitor: Press this button to listen to the output of a tape recorder connected to the **Tape Monitor** inputs **9**. A red LED indicator will illuminate above the button to indicate that the input source is being monitored when the HK3270 is connected to a three-head tape deck or another unit with off-head playback.

12 Tape 2: Press this button to listen to the output of a tape recorder or other device connected to the **Tape 2** inputs **11**.

13 CD Button: Press this button to listen to the output of a CD player connected to the **CD** inputs **7**.

14 AUX Button: Press this button to listen to the output of device connected to the **AUX** inputs **8**.

15 AM Button: Press this button to listen to radio stations in the AM (MW) frequency band.

16 FM Button: Press this button to listen to radio stations in the FM frequency band.

17 Tuning Button: Press the left side of the button to tune lower frequency stations and the right side of the button to tune higher frequency stations. When a station with a strong signal is tuned, the **TUNED** indicator will illuminate in the **Information Display 24**. A brief (1/2 second) press of the button will manually tune to the next frequency increment, while pressing and holding the button for a longer period will automatically tune to the next station with a signal strong enough for acceptable reception.

18 Preset Scan: Press this button to automatically scan through the stations that have been programmed in the HK3270's memory. The tuner will play five seconds of each station before moving to the next preset station. To stop the scan when the desired station is heard, press the button again. (See page 15 for more information on the tuner memory system.)

Front Panel Controls

9

19 Preset Stations Selector: Press this button to select stations that have been entered into the preset memory. (See page 15 for more information on tuner programming.)

20 FM Mode: Press this button to select the stereo or mono mode for FM tuning. In the STEREO mode a **Stereo** indicator will illuminate in the **Information Display** **24**, and stereo reception will be provided when stations are transmitting stereo signals. In the MONO mode the left and right signals from stereo broadcasts will be mixed together and reproduced through all channels. Select MONO for better reception of weak signals.

21 Mute: Press this button to momentarily silence the speaker output of the HK3270.

22 Volume Control: Turn the knob clockwise to increase volume, counterclockwise to decrease the volume.

23 Volume/Mute Indicator: This indicator will glow green when the HK3270 is turned on. Its position will enable you to judge the relative volume of the unit even when the speakers are muted or turned off. When the indicator is pointing towards the left, at an "8 o'clock" position, the volume is low; when it is pointing to the right, as in a "3 o'clock" position, the volume is loud. When the unit has been muted, pressing the **Mute** button **21** **L** the indicator will flash.

24 Information Display: This display delivers messages and status indications to help you operate the receiver.

25 Remote Sensor Window: The sensor behind this window receives infrared signals from the remote control. Aim the remote at this area and do not block or cover it unless an external remote sensor is installed.

Rear Panel Connections

10

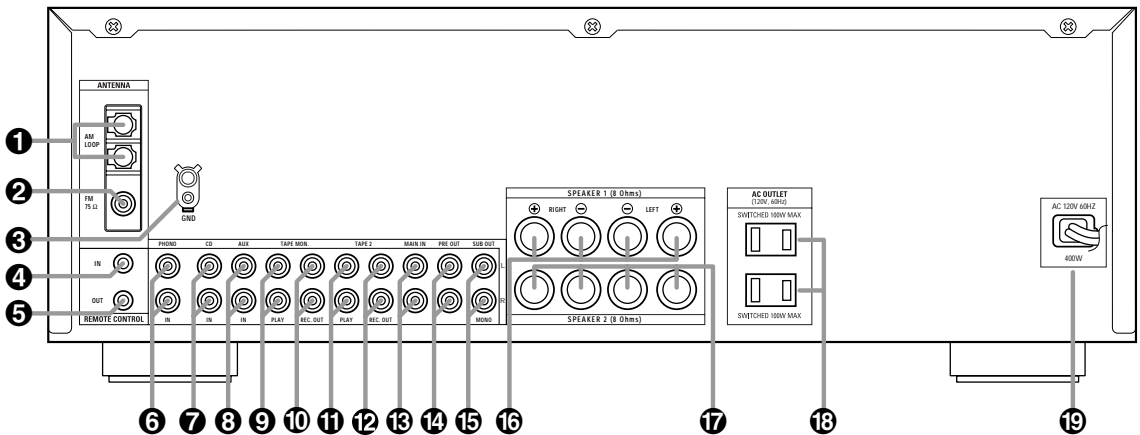

- ❶ AM Antenna
- ❷ FM Antenna
- ❸ Phono Ground
- ❹ Remote IR In
- ❺ Remote IR Out
- ❻ Phono Inputs
- ❼ CD Inputs

- ❸ Aux Inputs
- ❹ Tape Monitor Play/In
- ❺ Tape Monitor Record/Out
- ❻ Tape 2 Play/In
- ❼ Tape 2 Record/Out
- ❽ Main In
- ❿ Preamp In

- ❽ Subwoofer Out
- ❾ Speaker 1 Terminals
- ❿ Speaker 2 Terminals
- ⓫ Accessory Outlets
- ⓬ Power Cable

❶ AM Antenna: Connect the AM loop antenna supplied with the receiver to these terminals. If an external AM antenna is used, make connections to the **AM** and **GND** terminals in accordance with the instructions supplied with the antenna.

❷ FM Antenna: Connect an indoor or external FM antenna to this terminal.

❸ Phono Ground: Connect the ground wire from a turntable to this terminal to reduce system hum.

❹ Remote IR In: If the HK3270's front panel IR sensor is blocked due to cabinet doors or other obstructions, an external IR sensor may be used. Connect the output of the sensor to this jack.

❺ Remote IR Out: This connection permits the IR sensor in the receiver to serve other remote controlled devices. Connect this jack to the "IR IN" jack on Harman Kardon or other compatible equipment.

❻ Phono Inputs: Connect the outputs of your turntable or tone arm to these jacks. Note that only Moving Magnet (MM) type cartridges may be used.

❼ CD Inputs: Connect these jacks to the output of a compact disc receiver or CD changer.

❸ Aux Inputs: Connect these jacks to the line-level output of any audio device such as a TV, cable converter or portable audio player.

Rear Panel Connections

11

9 Tape Monitor Play/In: Connect these jacks to the Play/Out jacks of an audio recorder.

10 Tape Monitor Record/Out: Connect these jacks to the Rec/In jacks of an audio recorder.

NOTE: When these jacks are connected to a three-head recorder or another device with off-head playback, it will be possible to monitor the source being recorded.

11 Tape 2 Play/In: Connect these jacks to the PLAY/OUT jacks of a second audio recorder.

12 Tape 2 Record/Out: Connect these jacks to the Rec/In jacks of a second audio recorder.

13 Main In: These jacks are the input to the HK3270's power amplifier. Unless an external power amplifier is used, the jumper pins should remain connected to the **Preamp Out** jacks **14**.

14 Preamp Out: These jacks provided an output for the left and right channels to an optional external amplifier. In normal operation, unless an external power amplifier is used, the jumper pins should remain connected to the **Main In** jacks **13**.

15 Subwoofer Out: Connect these jacks to the line level input of a powered subwoofer. If an external subwoofer amplifier is used, connect this jack to the subwoofer amplifier input.

16 Speaker 1 Terminals: Connect these terminals to the appropriate terminals on your speakers.

17 Speaker 2 Terminals: Connect these terminals to the appropriate terminals on your speakers.

18 Accessory Outlets: These outlets may be used to power low-current draw devices such as CD players or cassette decks. Note that the power to these outlets will remain on as long as the **Main Power Switch 1** is pressed in. These outlets will continue to be powered even when the unit is in the Standby mode. To remove power to these outlets, the **Main Power Switch 1** must be placed in the OFF position.

NOTE: The power consumption of the devices plugged into these outlets should not exceed 100 watts.

19 Power Cable: Connect the AC plug to a non-switched AC wall output.

Remote Control Functions

12

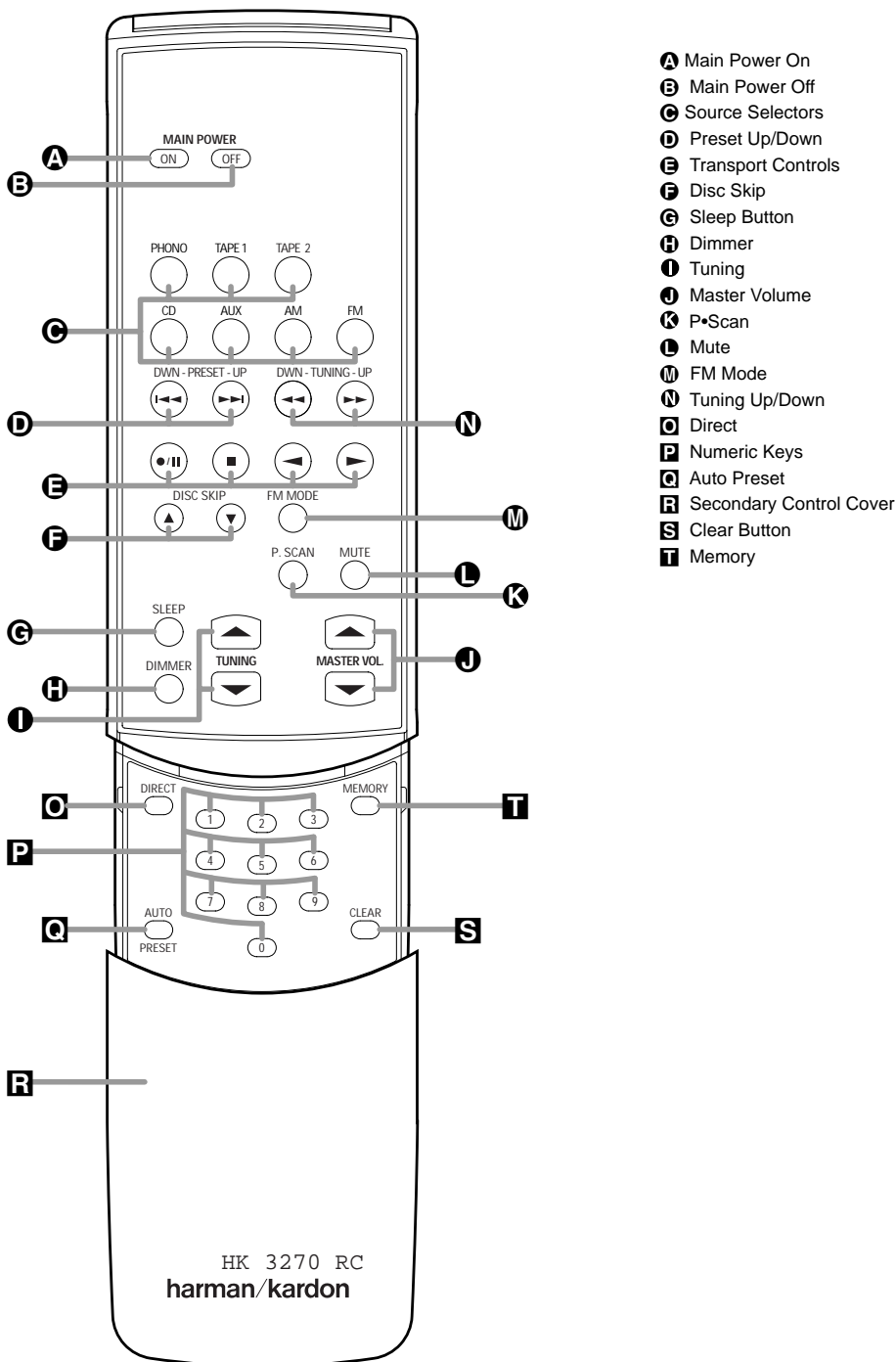

Remote Control Functions

13

A Main Power On: When the HK3270 is in the Standby mode, as indicated by the **Power Indicator 3** glowing amber, press this button to turn the HK3270 on.

B Main Power Off: When the HK3270 is turned on, press this button to place it in the Standby mode. Note that in this condition, the unit is still connect to AC Power.

C Source Selectors: Press these buttons to select an input source for the HK3270.

D Preset Up/Down: When the tuner is in use, these buttons scroll through the stations that have been programmed into the HK3270's memory. These buttons also control the track Skip Up and Down on compatible Harman Kardon compact disc players/ changers.

E Transport Controls: These buttons are used to control Play, Play Forward, Play Reverse, Stop, Pause and Record functions on compatible Harman Kardon compact disc players/ changers and cassette tape decks.

F Disc Skip: These buttons do not have any functions when controlling the HK3270, but they operate the Disc Skip functions of compatible Harman Kardon compact disc changers.

G Sleep Button: Press this button to place the unit in the Sleep mode. After the time shown in the display, the HK3270 will automatically go into the Standby mode. Each press of the button changes the time until turn-off in the following order:

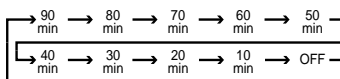

H Dimmer: Press this button once to reduce the brightness of the front panel display to half the normal intensity. Press it again to turn the front panel display completely off. When the display is completely off, press the button to return to normal brightness.

I Tuning: Press these buttons to tune up or down through a selected frequency band.

J Master Volume: Press these buttons to raise or lower the HK3270's volume.

K P•Scan: Press this button to automatically scan through the list of stations that are programmed into the HK3270's tuner memory. When the button is pressed, each preset station will play for five seconds before the next station is selected. Press the button again when the desired station is heard to stop the preset scan.

L Mute: Press this button to momentarily silence the HK3270.

M FM Mode: Press this button when the tuner is in use in the FM band to switch to monaural reception if the station is weak and noisy. When the **MONO** indicator is on, FM reception will be monaural regardless of the strength of the tuned FM station. (See page 15 for more information.)

N Tuning Up/Down: When the tuner is in use, these buttons will tune up or down through the selected frequency band. A brief (1/2 second) press of the button will manually tune to the next frequency increment, while pressing and holding the button for a longer period will automatically tune to the next station with a signal strong enough for acceptable reception. These buttons will also control Fast Forward and Fast Reverse (or Rewind) for compatible Harman Kardon compact disc players/ changers and cassette tape decks.

O Direct: Press this button to select a radio station by entering its frequency using the **Numeric Keys R**. (See page 15 for more information.)

P Numeric Keys: These buttons serve as a ten-button numeric keypad to enter tuner preset positions.

Q Auto Preset: When the tuner and FM band have been selected, this button may be used to automatically program the tuner presets for all active stations. To start the auto preset scan, press and hold the button. Note that the **MEMO** and **PRESET** indicators will flash. After a few seconds, the tuner will start to "look" for active stations, as shown by increasing frequency numbers in the Information Display. Release the button and note that the tuner will briefly stop at each active station and add a preset number to the memory. If the FM tuner found less than 30 FM stations with acceptable signal strength, the Auto Preset tuning will scan two more cycles or until the remaining vacant preset memory spaces have been filled with those found in the first scan. The scan will stop when all 30 preset memory spaces have been filled or when three scans through the band have been completed.

R Secondary Control Cover: This sliding cover normally is in the "up" position so that it hides the secondary controls. To access these controls, place your thumb on the small recessed area at the top center of the control, and gently press the cover down and towards you.

S Clear Button: This button is used to clear preset memory information for the HK3270's tuner. (See pages 15–16 for more information on tuner presets.)

T Memory: Press this button to open a memory position that stores a preset location for the HK3270's tuner. (See pages 15–16 for more information on tuner presets.)

Installation and Connections

14

System Installation

After unpacking the unit, and placing it on a solid surface capable of supporting its weight, you will need to make the connections to your audio and video equipment. These steps need to be done only when the receiver is first installed, or when a change is made to the input source equipment.

Audio Equipment Connections

We recommend that you use high-quality interconnect cables when making connections to source equipment and recorders to preserve the quality of the signals.

When making connections to audio source equipment or speakers it is always a good practice to unplug the unit from the AC wall outlet. This prevents any possibility of accidentally sending audio or transient signals to the speakers that may damage them.

1. Connect the analog output of a CD player to the **CD** inputs **7**.

NOTE: When the CD player has both fixed and variable audio outputs it is best to use the fixed output unless you find that the input to the receiver is so low that the sound is noisy, or high that the signal is distorted.

2. Connect the Play/Out jacks of a cassette deck, MD or other audio recorder to the **Tape Monitor In** jacks **9**. Connect the Record/In jacks on the recorder to the **Tape Monitor Out** jacks **10** on the HK3270. When the tape deck connected to these jacks is a three-head unit or has off-head playback, it will be possible to monitor the output of the source being recorded.

3. Connect the output of a second audio recorder, VCR or other line-level audio device to the **Tape 2 Play/In** jacks **11**. If a recorder is used, connect its Rec/In jacks to the matching outputs **1**.

4. The output of any electronics product with a line-level output, such as a TV set, satellite receiver or DVD may be connected to the **Aux** jacks **3**.

5. Connect the outputs of a turntable with a moving magnet cartridge to the **Phono** inputs **6**. To insure that the phono playback is noise-free, connect the ground wire from the tone arm to the **Phono Ground** terminal **4**.

6. Assemble the AM Loop Antenna supplied with the unit as shown below. Connect it to the **AM** screw terminals **1**.

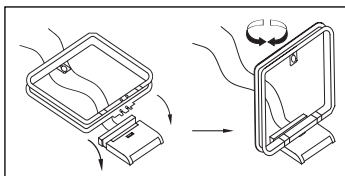

7. Connect an FM antenna to the **FM (75 ohm)** connection **2**. The FM antenna may be an external roof antenna, an inside powered or wire lead antenna or a connection from a cable TV system. Note that if the antenna or connection uses 300-ohm twin-lead cable, you must use the 300-ohm-to-75-ohm adapter supplied with the unit to make the connection.

Speaker and Output Connections

To assure that all the audio signals are carried to your speakers without loss of clarity or resolution, we suggest that you use high-quality speaker cable. Many brands of cable are available, and the choice of cable may be influenced by the distance between your speakers and this receiver, the type of speakers you use, personal preferences and other factors. Your dealer or installer is a valuable resource to consult in selecting the proper cable.

Regardless of the brand of cable selected, we recommend that you use a cable constructed of fine, multi-strand copper with a gauge of 14 or smaller. Remember that in specifying cable, the lower the number, the thicker the cable.

Cable with a gauge of 16 may be used for short runs of less than ten feet. We do not recommend that you use cables with an AWG equivalent of 18 or higher due to the power loss and degradation in performance that will occur.

Cables that are run inside walls should have the appropriate markings to indicate listing with UL, CSA or other appropriate testing agency standards. Questions about running cables inside walls should be referred to your installer or a licensed electrical contractor who is familiar with the NEC and/or the applicable local building codes in your area.

Installation and Connections

When connecting wires to the speakers, be certain to observe proper polarity. Remember to connect the “negative” or “black” wire to the same terminal on the receiver and the speaker. Similarly, the “positive” or “red” wire should be connected to the like terminal on the HK3270 and speaker.

We also recommend that the length of cable used to connect speaker pairs be identical. For example, use the same length piece of cable to connect the front left and front right or surround left and surround right speakers, even if the speakers are a different distance from the HK3270.

NOTE: While most speaker manufacturers adhere to an industry convention of using black terminals for negative and red ones for positive, some manufacturers may vary from this configuration. To assure proper phase, and optimal performance, consult the identification plate on your speaker, or the speaker’s manual to verify polarity. If you do not know the polarity of your speaker, ask your dealer for advice before proceeding, or consult the speaker’s manufacturer.

Connect the speakers using the following steps:

1. Connect the main speakers to the **Speaker 1** terminals ⑮.
2. Connect a second set of speakers, or speakers that are in a second room location to the **Speaker 2** terminals ⑰.

3. When an optional, powered subwoofer is used, connect the outputs of the **Subwoofer Out** jacks ⑮ to the line-level inputs of the subwoofer. When the subwoofer’s amplifier has stereo inputs, run interconnects from both jacks. When the subwoofer has a mono input only, use the bottom jack for the connection. When a passive subwoofer is used, these connections will be made to the optional amplifier that powers the subwoofer.

System and Power Connections

The HK3270 is designed for flexible use with external control components and power amplifiers. These connections are easy to make during an initial installation, or at a later date should you choose to upgrade your system.

Remote Control Extension

If the receiver is placed behind a solid or smoked glass cabinet door, the obstruction may prevent the remote sensor from receiving commands. In this event, an optional remote sensor may be used. Connect the output of the remote sensor to the **Remote Cont. In** jack ④.

If other components are also prevented from receiving remote commands, only one sensor is needed. They may use this unit’s sensor or a remote eye by running a connection from the **Remote Cont. Out** jack ⑤ to the Remote In jack on Harman Kardon or other compatible equipment.

External Audio Power Amplifier Connections

If desired, an optional, external amplifier may be used in place of the HK3270’s internal power amplifier.

To connect an external power amplifier, first remove the jumper pins that connect the **Preamp Out** ⑭ and **Main In** ⑬ jacks on the rear panel. Keep the jumpers in a safe place should they be needed at a later time.

Using high-quality audio interconnect cables, connect the **Preamp Out** jacks ⑭ to the input jacks on your power amplifier. Make certain to match the right output to the right input and the left output to the left input.

Note that when an external power amplifier is used, no special adjustments are required. All volume and other control adjustments are made using the standard front panel or remote controls.

AC Power Connections

The **Accessory Outlets** ⑮ receive power as long as the **Main Power Switch** ① is in the “ON” position. Power will still be supplied to these outlets even when the HK3270 is in the Standby mode.

In order to remove power to these outlets, the unit must be turned off by pressing the **Main Power Switch** ① so that it is in the “OFF” position.

Installation and Connections

Speaker Placement

For optimal listening enjoyment, and for soundfield reproduction that best re-creates the original recording, it is good practice to place the speakers so that they form a triangle with the speakers at the front of the room, and the preferred listening spot at the third point of the triangle. The distance between each speaker and the listener should be identical.

For example, if the speakers are 2.5 meters from one another, each of the speakers should optimally be placed so that they are also 2.5 meters from the listener. It is also desirable to place speakers so that their tweeters, or high-frequency drivers are aimed at ear height when you are seated in the listening position.

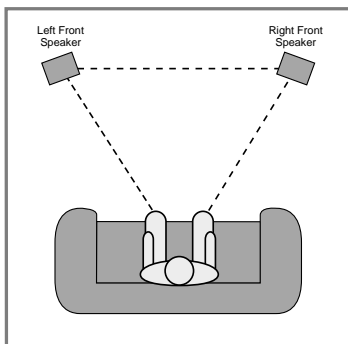

A good starting point for speaker placement is to make the distance between the two speakers and the distance between either speaker and the listener is identical.

To optimize the soundfield, or to suit your listening room environment, you may find that some experimentation is required to find the correct location. Ideally, pans from left to right across the front of the room should sound smooth, and instruments should appear to be coming from the proper location to where they would be placed in an orchestra.

The placement of subwoofers should be done as suggested in the manufacturer's instructions. In general, subwoofers often produce best results when they are placed in the corner of a room, but optimal placement will vary widely depending on room size, the subwoofer type and the placement of rugs and furniture in a room.

Finally, when all connections are complete, plug the power cord into a non-switched 120-volt AC wall outlet. You're ready to enjoy the HK3270!

Operation

17

Basic Operation

Once you have completed the setup and configuration of your new receiver, it is simple to operate and enjoy. The following instructions will provide the steps needed to enjoy the HK3270:

- Install the two supplied AAA batteries in the remote as shown. Be certain to observe the (+) and (-) polarity indicators shown in the bottom of the battery compartment.

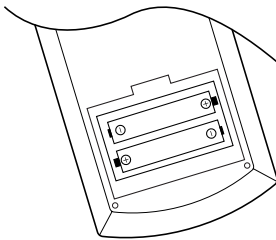

- When using the HK3270 for the first time, it is necessary to press the **Main Power** button **1** on the front panel to turn the unit on. This places the unit in a standby mode, as indicated by the amber color of the **Power Indicator** **3**. Once the unit is in standby, you may begin a listening session by pressing the **System Power Control** **2** on the front panel or the **Main Power On** button **A** on the remote. Note that the **Power Indicator** **3** will turn red, then green. This will turn the unit on and return it to the input source that was last used. The unit may also be turned on from standby by pressing any of the **Source Selector** buttons on the front panel **10 11 12 13 14 15 16**.

To turn the unit off at the end of a listening session simply press the **System Power Control** **2** on the front panel or the **Main Power Off** button **B** on the remote. This places the unit in the Standby mode, and the **Power Indicator** **3** will turn amber to remind you that the unit is ready for operation when a power command is received from the remote. Please note that power will still be applied to the **Accessory Outlets** **13** even when the unit is in the Standby mode.

When the remote is used to turn the unit “off” it is actually placing the system in a standby mode, as indicated by the amber color of the **Power Indicator** **3**.

When you will be away from home for an extended period of time it is always a good idea to completely turn the unit off using the front panel **Main Power Switch** **1**.

- To dim the brightness of the front panel display, press the **Dimmer** button **H** on the remote. The first press will dim the lights to half normal. A second press will turn the display completely off. Press the **Dimmer** button **H** again to restore the display to normal brightness.

Source Selection

- To select a source at any time, press any of the **Source Selector** buttons on the remote **C** or front panel **10 11 12 13 14 15 16**.
- During a listening session you may wish to adjust the **Bass** **7** and **Treble** **8** and **Balance** **9** controls to suit your listening tastes.

- Adjust the volume to a comfortable level using the front panel **Volume Control** **22** or remote **Master Volume Up/Down** **1** buttons.

- To temporarily silence all speaker outputs press the **Mute** button **L 21**. This will cut the output to all speakers, but it will not effect any recording or dubbing that may be in progress. When the system is muted the MUTE indicator will light in the **Information Display** **24** and the **Volume/Mute** indicator **23** will flash. Press the **Mute** button **L 21** again to return to normal operation.

- For private listening, plug the 1/4" stereo phone plug from a pair of stereo headphones into the front panel **Headphone** jack **4**.

- One or two separate sets of speakers may be connected to the HK3270. To listen to one of the speaker sets press the **Speaker** buttons **5 6** on the front panel corresponding to the desired speakers. Both speakers may be turned off for private headphone listening.

- To program the HK3270 for automatic turn off, press the **Sleep** button **G** on the remote. Each press of the button will increase the time before shut down in the following sequence:

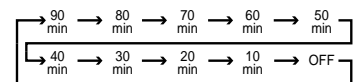

The sleep time will be displayed in the Information Display and it will count down until the time has elapsed.

Operation

18

When the programmed time has elapsed the unit will automatically turn off. Note that the front panel display will dim to one half brightness when the Sleep function is programmed. To cancel the Sleep function, press the **Sleep** button **Ⓞ** until the Sleep indicator numbers disappear and the Information Display shows the current source. Pressing any control button while the Sleep control is activated will momentarily return the Information Display to full brightness for increased legibility without interrupting the Sleep function.

Tuner Operation

The HK3270's tuner is capable of tuning AM, FM and FM Stereo broadcast stations. Stations may be tuned manually, or they may be stored as favorite station presets and recalled from a 30-position memory.

Station Selection

1. Press the **AM** **15** or **FM** **16** buttons on the front panel or on the remote **Ⓞ** to select the tuner as an input.

2. Press these buttons again at any time to switch between AM and FM.

3. To select stations press, and briefly hold, the **Tuning** button **17** **Ⓚ** and the tuner will search for the next highest or lowest frequency station that has an acceptable signal. To tune to the next station, press the button again. Tap the **Tuning** button **17** **Ⓚ** to advance one frequency increment at a time, or press and hold it to locate a specific station. When the **TUNED** indicator illuminates, the station is properly tuned and should be heard with clarity.

4. Stations may also be tuned directly by pressing the **Direct** button **18**, and then pressing the **Numeric Keys** **19** that correspond to the station's frequency. The desired station will automatically be tuned.

NOTE: When the FM reception of a station is weak, audio quality will be increased by switching to Mono mode by pressing the **FM Mode** button **20** **Ⓜ** until the **STEREO** indicator goes out.

Preset Tuning

Up to 30 stations may be stored in the HK3270's memory for easy recall using the front panel controls or the remote.

To enter a station to the memory, first tune the station using the steps outlined above. Then:

1. Press the **Memory** button **11** on the remote. Note that **MEMO** and **PRESET** indicators will illuminate and flash in the Information Display.

2. Within five seconds, press the **Numeric Keys** **19** corresponding to the location where you wish to store this station's frequency.

3. Repeat the process after tuning any additional stations to be preset.

Auto Preset

- Preset stations may also be programmed automatically for the FM band. To automatically enter each station that may be tuned with acceptable quality into the HK3270's preset memories, first select the FM band. Next, press and briefly hold the **Auto Preset** button **21** until the **MEMO** and **PRESET** indicators begin to flash, and the station

frequency indication begins to increase. Release the button and note that the tuner will search the entire FM band, and stop briefly at each station that has acceptable signal strength. The HK3270 will automatically assign a preset number to each station, and then search for the next station. The automatic scan process will stop when all 30 preset memory locations have been filled or the entire FM band has been scanned three times.

NOTE: Using the automatic tuning mode in areas with more than 30 FM stations will completely fill the preset memories, and over-write any previously memorized presets for either AM or FM stations.

TIP: The automatic scan process may enter stations that you do not wish to retain in the memory, or it may enter a station on more than one frequency if the signal is too strong. These unwanted stations may be removed from the memory using the **Preset Clear** function outlined below.

Recalling Preset Stations

- To manually select a station previously entered in the preset memory, press the **Numeric Keys** **19** that correspond to the desired station's memory location.

- To manually tune through the list of stored preset stations one by one, press the **Preset** buttons **19** **Ⓚ** on the front panel or remote.

- To automatically scan through the stations entered in the preset memory, press the **Preset Scan** button **18** **Ⓚ** on the front panel or remote. The tuner will run through the list of preset stations, stopping for five seconds at each one. Press the button again to stop the scan at your desired station.

Operation

19

Clearing Preset Stations

Unwanted preset stations may be erased from the unit's memory to make it easier to tune only those stations you want.

To remove a preset station from the HK3270's tuner memory, first tune to the station using the **Preset Scan** button **⏮** **⏪** on the front panel or remote, or by entering the preset number directly, using the **Numeric Keys** **1-9**.

When the preset station to be removed has been tuned, first press the **Memory** button **M**. The MEMO and PRESET indicators in the Information Display will flash, and the actual preset number will disappear from the display. Next, press the **Clear** button **S** within five seconds.

The preset station will be removed from the memory, and the action will be confirmed by the brief appearance of the word CLEAR and the preset number location in the Information Display. That memory location will now be empty, and you may program a different station to that location, or leave it empty.

Tape Recording

In normal operation, the audio source selected for listening through the HK3270 is sent to the Tape Mon Out and Tape 2 Rec Out outputs. This means that any program you are listening to may be recorded simply by placing machines connected to the outputs for **Tape Monitor** **10** or **Tape 2** **11** in the record mode.

When a tape recorder with separate record and playback heads is used, you may monitor the output of the recording by selecting the **T•Mon** **11** or **Tape 1** **10**. Note that a red LED will illuminate in the front panel above the **T•Mon** **11** to remind you that you are listening to the record playback instead of the actual input source being recorded.

IMPORTANT NOTE: Please make certain that you are aware of the copyright restrictions on any material you copy.

Memory Backup

This product is equipped with a memory backup system that preserves tuner presets and system configuration information if the unit is accidentally unplugged or subject to a power outage.

Processor Reset

In the rare case where the unit's operation or the displays seem abnormal, the cause may involve the erratic operation of the system's memory or microprocessor.

To correct this problem, first unplug the unit from the AC wall outlet and wait at least three minutes. After the pause, reconnect the AC power cord and check the unit's operation. If the system still malfunctions, a system reset may clear the problem.

If the system still does not respond, it may be necessary to perform a complete reset. To reset the system, first turn the HK3270 off by pressing the **Main Power Switch** **1** and then releasing it so that it extends out beyond the front panel and the word "OFF" is visible in red lettering at the top of the switch.

Next, press and hold the **T•Mon** and **CD Input Selector** buttons **11** **13** on the front panel ONLY. While holding these buttons in, press the **Main Power Switch** **1** in until it latches so that the button is flush with the front panel.

The Information Display will briefly show the word RESET, and then return to normal operation.

Note that when the system is reset in this fashion, all tuner presets will be lost and must be reentered.

If the system is still operating incorrectly, there may have been an electronic discharge or severe AC line interference that has corrupted the memory or microprocessor.

If these steps do not solve the problem, consult an authorized Harman Kardon service depot.

Troubleshooting Guide

20

This unit is designed for trouble-free operation. Most problems users encounter are due to operating errors. So, if you have a problem, first check this list for a possible solution. If the problem persists, consult your authorized Harman Kardon Service Center.

If the problem is...

Make sure that the...

No lights illuminate when POWER button is pressed

Unit is plugged into a live outlet
Main power switch is pressed in

No sound is heard

Unit has not been muted
Correct input function selector button has been pressed
Volume is turned up

No output from one or more channels

Cables are not defective: Check/replace speaker cables

Tuner sound has a large amount of interference, or
The "Stereo" display is not illuminated, or
Tuner sound distorts and/or volume level is too low

The antenna is properly connected
The antenna is properly located
The antenna is set in the proper direction
The antenna is adequate to receive the desired station

Tuner is intermittent or continuously buzzing or hissing

The unit is away from fluorescent lights, TVs, motors and other electrical appliances

Technical Specifications

21

Audio Section

Stereo Mode	
Continuous Average Power (FTC)	
65 Watts per channel, 20Hz–20kHz	
@ < 0.08% THD, both channels driven into 8 ohms	
95 Watts per channel, 20Hz–20kHz	
@ < 0.2% THD, both channels driven into 4 ohms	
Input Sensitivity/Impedance	
Linear (High Level)	200mV/47kohms
Signal-to-Noise Ratio (IHF-A)	95dB
Frequency Response	
@ 1W (+0dB, -3dB)	10Hz–80kHz
High Instantaneous Current Capability (HCC)	±42 Amps
Transient Intermodulation Distortion (TIM)	Unmeasurable
Rise Time	16 µsec
Slew Rate	40V/µsec

FM Tuner Section

Frequency Range	87.5–108MHz
Usable Sensitivity	IHF 1.12 µV/12.3dBf
Signal-to-Noise Ratio	Mono/Stereo 72/70dB
Distortion	Mono/Stereo 0.3/0.5%
Stereo Separation	40dB @ 1kHz
Selectivity	±400kHz, 65dB
Image Rejection	>80dB
IF Rejection	>100dB
Tuner Output Level	1kHz, ±100kHz Dev 500mV

AM Tuner Section

Frequency Range	520–1710kHz
Signal-to-Noise Ratio	>40dB
Usable Sensitivity	Loop 500 µV/M
Distortion	1kHz, 50% Mod 0.8%
Selectivity	±10kHz, >25dB

General

Power Requirement	AC 120V/60Hz
Power Consumption	72W idle, 332W maximum (both channels driven)

Dimension (Max)

Width	17.4 inches (442mm)
Height	6.1 inches (156mm)
Depth	16.3 inches (415mm)
Weight	24.6 lbs. (11.2 kg)

Depth measurement includes knobs, buttons and terminal connections.

Height measurement includes feet and chassis.

All features and specifications are subject to change without notice.

Staple or clip original invoice here. ▼

harman/kardon HK 3270

